

Challenger

Microcut

CNC Horizontal Milling and Boring Center



Table type
T-type
Ø110/Ø130 spindle

HBM LINE

BUFFALO MACHINERY CO., LTD.
56, Lane 318, Der Sheng Road, Ta Ya, Taichung City, Taiwan, R.O.C.
P.O. Box 320, Ta Ya, Taichung City, Taiwan R.O.C.
Tel: 886-4-25 60 37 59 Fax: 886-4-25 60 37 69 E-mail: info@mail.buffalo.com.tw
www.buffalo.com.tw





Buffalo Machinery has been committed to the field of metal working machinery since the company was founded in 1978 and has acquired a great experience of machine tools manufacturing knowledge. Since year 1997, Buffalo Machinery started the production of CNC machines, up to now, a complete line of metal working machine has been continuously developed, which meets the requirement of various metal-cutting industries. In the last 14 years, Buffalo Machinery has built up its own 8 production factories in Taichung City, Taiwan. The demand of the market increases so strong that the productivity is not enough to accommodate. Today, Buffalo Machinery has reached the point as being one of the major world-known metal-working machinery development and production facility, and continues to pursue excellence in quality and service. Microcut the Challenger metal-working machines are highly efficient with the features of innovative design which are highly percentage marketed in top quality market, the potential are looking for high speed, high productivity. Microcut the Challenger has built high satisfaction from its feedback. Meanwhile Buffalo Machinery provides high quality products and excellent grade of after sales service, it definitely can be considered as one of the best partners to work with!

Base on the high quality, reliable products and efficient after sales service, Microcut the Challenger products has been well marketed internationally. In year 2008, Buffalo Machinery has been certified to the ISO9001-2008 quality standards and the ISO14001-2004 certification standards. In the same year, Buffalo Machinery awarded National Award of Outstanding Small and Medium Enterprise in year 2008. Microcut the Challenger CNC machines are a range of reliable products that can always satisfy the needs of every single customer.

The HBM series horizontal milling and boring machine are able to provide a wider selection of working capability and can meet various potential needs. The large loading capacity working tables can be widely utilized in the energy industry, mining industry, oil & gas industry, and die & mold industry. Besides the model HBM-4 with working table type, a wide range of T-type HBM series have been developed, such as model HBM-4T and HBM-5T have been successfully serviced in the field. The company is targeting to develop Floor Type Boring Mills, Ram Type Boring Mills and Ram Type CNC Mills. These models will be announced in late 2012.



HBM-4

Travel: X, Y, Z 2200 x 1600 x 1600mm
W 550mm
Maximum load on table center: 5 tons
Spindle torque: 740Nm(std.) / 863Nm(opt.)
Spindle diameter: 110mm
Spindle motor: 15/18.5Kw(std.) / 18.5/22Kw(opt.)
Construction of one-piece bed is optional.

HBM-4T

Travel: X:2000mm(std.)/3000mm(opt.)
Y: 2000mm(std.)
Z: 1400mm(std.)/2000mm(opt.)
W1: 700mm
Table size:
1400x1600mm 8 tons(std.)
1600x1800mm 10 tons(opt.)
Spindle torque:3002Nm
Spindle motor:22/30Kw(Fanuc)
Spindle diameter:130mm



HBM-5T

Travel: X: 3500mm(std.)/4500mm(opt.)
5500mm(opt.)
Y: 2600mm(std.)
Z: 1400mm(std.)/2000mm(opt.)
W1: 700mm
Table size:1800x2200mm
Max. table load:15 tons(std.)/20 tons(opt.)
Spindle torque:2362Nm
Spindle motor:37/45Kw(Fanuc)
Spindle diameter:130mm

HBM-5TL

Travel: X: 4500mm(std.)/5500mm(opt.)
Y: 3200mm(std.)
Z: 2000mm(std.)
W1: 700mm(std.)
Table size:2500x2500mm
Max. table load:20 tons(std.)/30 tons(opt.)
Spindle torque:2362Nm
Spindle motor:37/45Kw(Fanuc)
Spindle diameter:130mm



Model HBM-4
Table Type Borer



Rotary table

- Large diameter supporting bearing surface for heavy loading capacity.
- 3-piece Hirth couplings transmission and clamping for precise positioning every 1 degree standard table and multi-pitch worm gear for transmission system offers 0.001 degree variable positioning on request.
- Generous dimensioning of the hydraulic clamping system which enables the capability for heavy cutting.
- Integrated chip auger located below cutting areas for easy chip removal.

Spindle & Gear box

- 110mm quill diameter with travel 550mm for deep hole boring and milling.
- The main headstock supporting part is made of grade GGG iron casting. Spindle and sleeve are made of chrome alloyed steel which performs a great reliability.
- The spindle and quill is driven by the servo unit and lubricated by sintered bronze in order to ensure durability and longevity.
- A two-speed gear box, featuring two big ratios (1:6 for roughing operations, and 1:2 for normal work). Speed step shifts automatically according to the spindle speed setting.
- Coolant through spindle device is prepared for easy retrofit.



Bed

- All major structural components are made of Meehanite licensed casting iron with stress released, ensuring maximum stability and rigidity.
- Harden & ground box way offer great heavy loading capacity and high reliability.
- 2 additional support ways to ensure accuracy & rigid support for the large longitudinal travel.
- Absolute linear measuring system for 3 axes on request.

Model HBM-4T
Column Moving
Type Borer



Spindle

- 130mm quill diameter with travel 700mm for deep hole machining. Head structure is prism shaped 400x400x2330 mm.
- The interface for main headstock supporting part is made of grade GGG iron casting. The slide coating on the bearing surface in hand scrapped finish which ensures high precision assembly.
- The spindle and quill is driven by the servo unit. Sintered bronze made front Ring is to ensure easy maintenance, reliability and longevity.
- A two-speed planet gear box, featuring two large ratios (1:5.5 for roughing operations, and 1:1 for normal work). Speed step shifts automatically according to the spindle speed setting.

Rotary table

- Both the table slide and clamping plates are made of a robust cross-ribbed casting which is treated by thermal stabilization.
- Centrally integrated rotary encoder guarantees precision positioning and easy maintenance.
- 0.001 degree variable positioning in any angular position and available for rotary milling.
- Dual worm-gear driven system ensures backlash free.
- 3 rings of bearing surface coated and hand-scrapped treated for stable and longevity.
- The rotary table is reinforced with integrated hydraulic clamping force and four points lock pins provides heavy loading capacity and large clamping force.



X-axis and Z-axis

- All major structural components are made of Meehanite licensed casting iron with stress released, ensuring maximum stability and rigidity.
- Two roller type linear guideways with six pieces blocks for both axes offers heavy loading and high accuracy.
- Absolute linear measuring system for precise positioning.



Y-axis

- The machine column and slide are joined in a one unit fabricated from a robust cast. The device provides maximum rigidity and strength of the slide/column structure.
- Y-axis is driven by a braking motor and a N.C electromagnetic brake system adopted in the end of ballscrew as a safety security.

Model HBM-5T/5TL Column Moving Type Borer

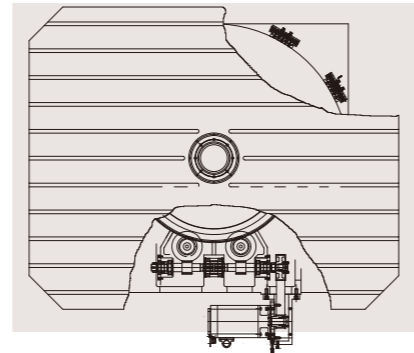
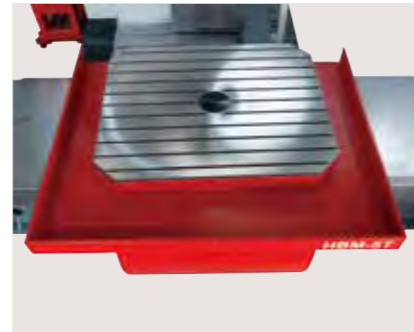

Spindle

- 130mm quill diameter with travel 700mm for deep hole machining. Head structure is prism shaped 400x400x2330 mm.
- Spindle is supported by cylindrical roller bearings (double roller) for heavy duty machining.
- Spindle and sleeve provides high precision accuracy. The spindle surface hardness is around HRC52-55.
- The spindle is equipped with automatic OTT Jakob tool chuck collets using disc springs with chucking power booster; release is provided by the hydraulic cylinder.

Rotary table

- Both the table slide and clamping plates are made of a robust cross-ribbed casting which is treated by thermal stabilization.
- Centrally integrated rotary encoder guarantees precision positioning and easy maintenance.
- 0.001 degree variable positioning in any angular position and available for rotary milling.
- Dual worm-gear driven system ensures backlash free.
- 3 rings of bearing surface coated and hand-scrap treated for stable and longevity.
- The rotary table is reinforced with integrated hydraulic clamping force and four points lock pins provides heavy loading capacity and large clamping force.



X-axis and Z-axis

- All major structural components are made of Meehanite licensed casting iron with stress released, ensuring maximum stability and rigidity.
- Two roller type linear guideways with six pieces blocks for both axes offers heavy loading and high accuracy.
- Absolute linear measuring system for precise positioning.



Y-axis

- The machine column and slide are joined in a one unit fabricated from a robust cast. The device provides maximum rigidity and strength of the slide/column structure.
- Y-axis is driven by a braking motor and a N.C electromagnetic brake system adopted in the end of ballscrew as a safety security.

High finish quality

- Spindle vibration suppression

Longer life time

- Wear reduction on spindle bearings and tools

Vibration data recorder

- Abnormal vibration data recorded for maintenance

Spindle Vibration implies lots of important information such as unusual spindle conditions (e.g. lubrication shortage, worn bearings, out-of-balance or even crash). Also, the vibration information can be used as the index of chatter-free control to eliminate the undesired chattering during machining. A motion sensor is integrated into the spindle to gather the vibration data. According to the recorded vibration data, the status of the spindle and machine can be identified.

If the vibration exceeds setting level, three data will be recorded.

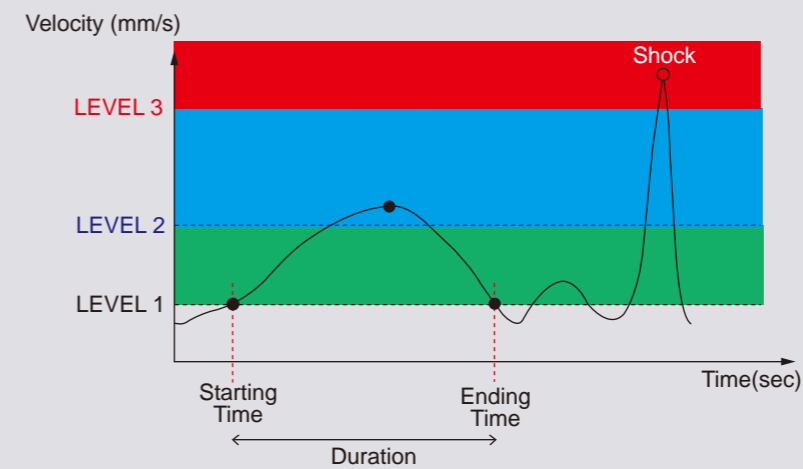

Three levels for spindle vibration monitoring:

- First level: shows the warning message when the vibration occurs and notifies the operator.
- Second level: shows the error message and reduces spindle speed and feed rate.
- Third level: when vibration reaches level 3 the machine will be shut down immediately to prevent crash.



Fig.1 Vibration report without compensation

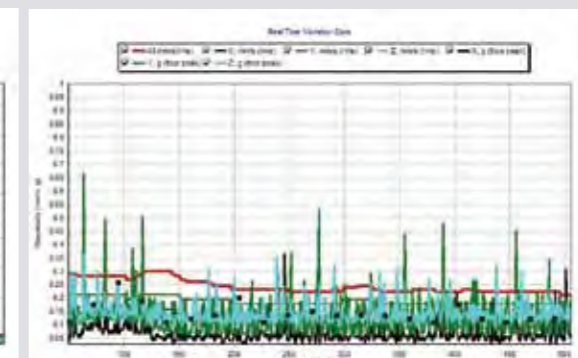
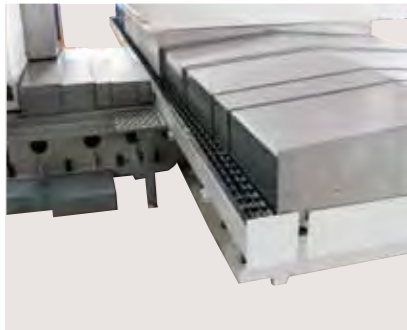

Fig.2 Vibration report with compensation



High precision ballscrews

- C3 class ballscrews with double nuts are applied on X/Y/Z/W axes which offer high axis accuracy and less deforming under axial force.
- All the ballscrew nuts are preloaded to ensure less tension deforming. Ballscrews are pretended for thermal compensation.
- Ballscrew supporter offered as standard on travel 3-meter and up ease the ballscrew deformation and ensure axes traverse in most smooth.



Chip arrangement

Machine is equipped with chip auger which carries out the chips to chip trolley. Floor chip conveyor is available if required.

Lubrication system



- Automatic lubrication system uses pressure-released type lubricator, oil volume is controlled by distribution metered values.
- Oil is supplied according to the lubrication oil demand of the sliding surface and the ball screw.
- Oil level detector unit is provided.
- Alarm will be shown on screen while oil supply is short. Sealed type spindle bearings are lubricated by grease.



Measuring system

The X, Y, Z axes are equipped with absolute linear scale. W axis is measured by the axis servo motor. The rotary table integrated with rotary encoder, providing resolution +/- 5". Spindle speed is measured by rotary sensor which is built in spindle motor.

Wide Selection of CNC



Heidenhain iTNC530 HSCI



Fanuc 31i/32i control



Siemens 840D SL

Portable MPG



Portable control panel
Fanuc/Siemens



Portable control panel
Heidenhain

All systems provide full control of 5 machines axes plus spindle rotation. Control system in basic configuration consists of:

- Standard software functions
- 15" color display (Heidenhain) / 10.4" color display (Fanuc/Siemens)
- Operational panel with keyboard
- Portable auxiliary control panel with electronic hand wheel
- Rigid tapping
- USB / Ethernet
- Tool management
- Helical

In addition, control functions may equip with:
Measuring touch probes
Additional rotary table
Automatic universal or angel heads
Please refer to Sales Manual for more details.

Optional Accessories



Automatic Tool Changer

60 tools chain type ATC for HBM-4T/5T/5TL

28 tools or 60 tools ATC for HBM-4

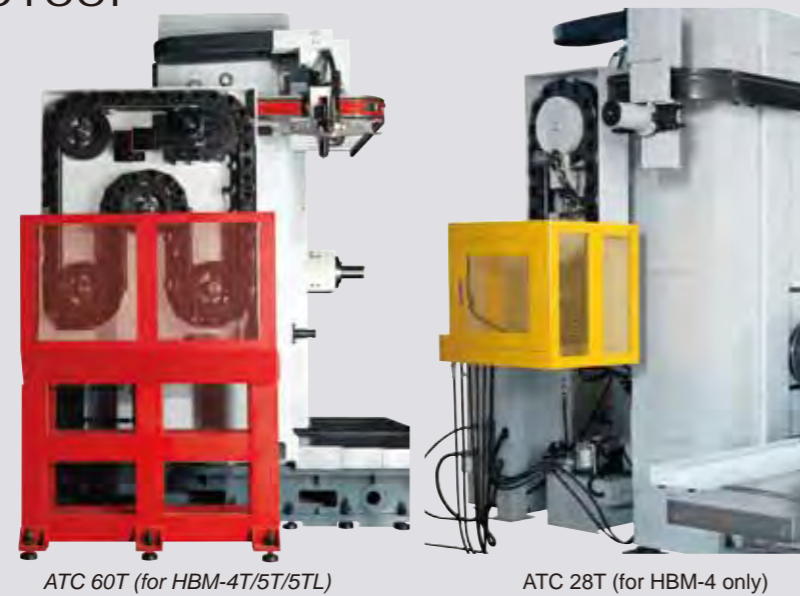

Specifications

Model	Unit	HBM-4	HBM-4T	HBM-5T	HBM-5TL
Table					
Table size	mm	1200 x 1500(std.) 1250 x 1500(opt.)	1400 x 1600(std.)/1600 x 1800(opt.)	1800x2200	2500x2500
Table height	mm	1100	1250	1250/1350	1400
T-slot(w/pitch/no)	mm	22H8x150x7	22H8x160x9	22H8x160x11	28H8x160x15
Max. table load	tons	5	8(std.)/10(opt.)	15(std.)/20(opt.)	20(std.)/30(opt.)
Table index	degree	1°(std.)/0.001°(opt.)		0.001°	
Rotary table positioning accuracy	sec.	15		15	
Rotary table repeatability accuracy	sec.	4		4	
Rotary table encoder accuracy	sec.	±5		±5	
Travel					
X axis - standard	mm	2200	2000	3500	4500
X axis - option	mm	-	3000	4500 / 5500	5500
Y axis	mm	1600	2000	2600	3200
Z axis - standard	mm	1600	1400	1400	2000
Z axis - option	mm	-	2000	2000	-
W1 axis	mm	550	700	700	700
W2 axis	mm	-	-	-	-
Distance between spindle nose to table center(standard Z-travel & table size)	mm	105~2255	-30~2070	-100~2000	250~2950
Spindle					
Spindle taper		ISO 50	ISO 50	ISO 50	
transmission		Gear	Gear	Gear	
Spindle speed	rpm.	35-3000	35-3000	35-3000	
Spindle output (Fanuc)	kw	15/18.5	22/30	37/45(std.)	
Spindle torque	Nm	726 / 863	1976/3002	1942/2362(std.)	
Spindle step		2 step	2 step	2 step	
Quill diameter (W axis)	mm	110	130	130	
Spindle bearing I/D	mm	150	170	170	
Axes Transmission					
X axis ballscrew	mm	ø55xP12xC3	ø80xP10xC3	ø80xP10xC3	ø80xP10xC3
Y axis ballscrew	mm	ø55xP12xC3	ø63xP10xC3	ø63xP10xC3	ø63xP10xC3
Z axis ballscrew	mm	ø55xP12xC3	ø80xP10xC3	ø80xP10xC3	ø80xP10xC3
W axis ballscrew	mm	ø40xP5xC3	ø40xP5xC3	ø40xP5xC3	ø40xP5xC3
Motor output					
Axes motor (X/Y/Z/B/W)	Nm	22/38/22/22/12	75/38/38/38/22	75/38/38/38/22	75/38/38/38/22
hydraulic motor	kw	3.75		7.5	
Coolant motor	kw	1.7		1.7	
Lubrication pump motor	W	25		25	
Guide way					
X axis guide way type		Box way	2 Linear way	3 Linear way	3 Linear way
X axis guide distance	mm	700	1010	1250	1250
Y axis guide way type		Box way		Box way	
Y axis guide distance	mm	540	1120	1120	1120
Z axis guide way type		Box way	2 Linear way	3 Linear way	3 Linear way
Z axis guide distance	mm	1000	954	1374	1374
Axes feed rate					
X/Y/Z/W rapid feed	m/min.	12/12/12/6	10/10/10/8	10/10/10/8	10/10/10/8
X/Y/Z/W cutting feed	m/min.	10/10/10/6		10/10/10/5	
B axis cutting feed	rpm	5.5(1°) / 2(0.001°)		1.5	
ATC system					
ATC type		Arm		Arm	
No. of tool		28/60		60	
Tool shank type		BT/CAT/DIN#50		BT/CAT/DIN #50	
Tool changing time(T-T)	sec.	9		16	
Max. tool diameter	mm	125		125	
Max. tool diameter with next tool empty	mm	250		250(std.) / 450(opt.)	
Max. tool length	mm	300/500		300(std.) / 500(opt.)	
Max. tool weight	kgs	25		25	
Max. loading weight	kgs	900		900	
Dimension					
Length	mm	7750	7800	8450(Z1400)/9050(Z2000)	9055(Z2000)
Width	mm	4715	7050/7800	6980(X3500)/8500(X4500)/9720(X5500)	8500(X4500)/9720(X5500)
Height	mm	3706	4600	5040	8115
Weight	kgs	22500	40000	49000	55000

*Specifications subject to change without notice.

Torque & horse power chart FANUC control

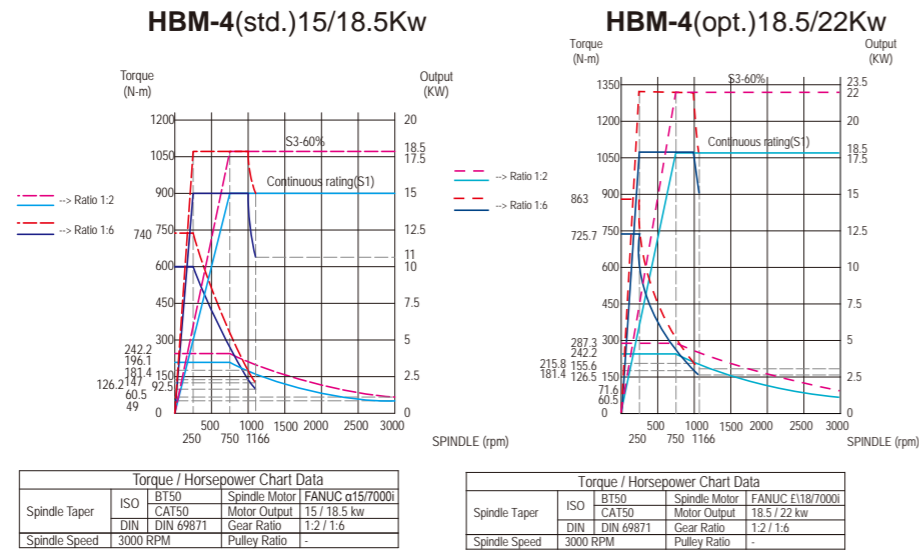

Heidenhain & Siemens control

HBM-4 --Heidenhain

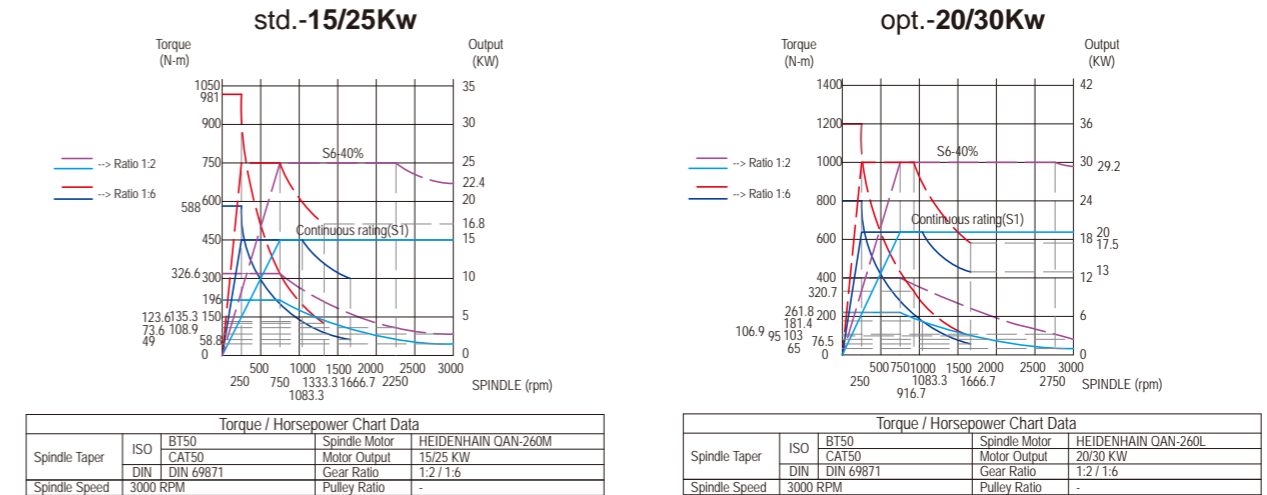

HBM-4 --Siemens

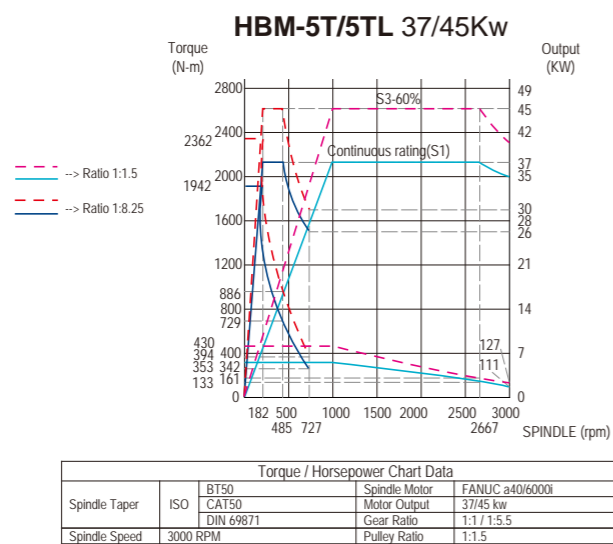
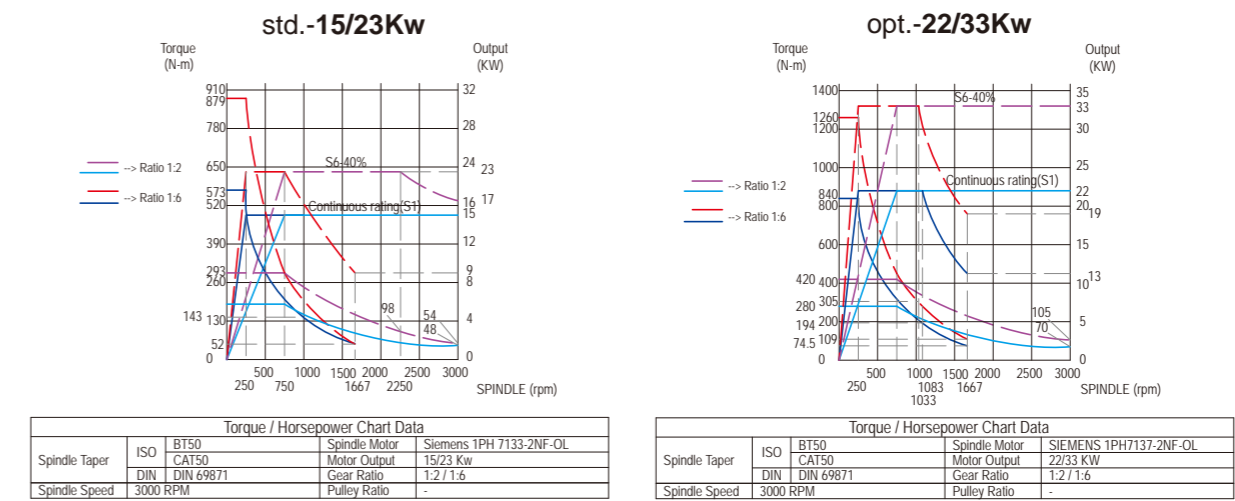

HBM-4T/5T Siemens & Heidenhain (Heidenhain CNC is equipped with Siemens motors)

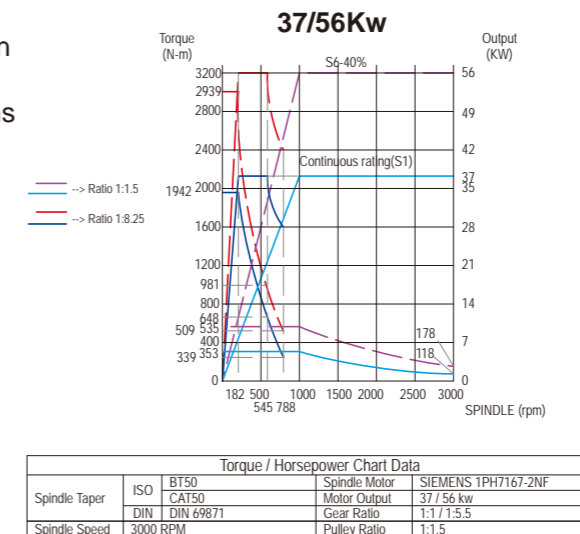

Interference drawing

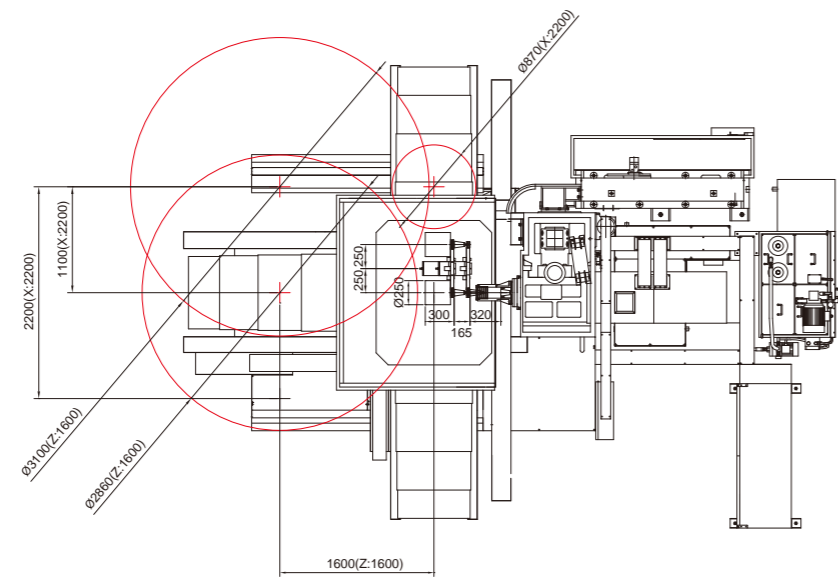

HBM-4

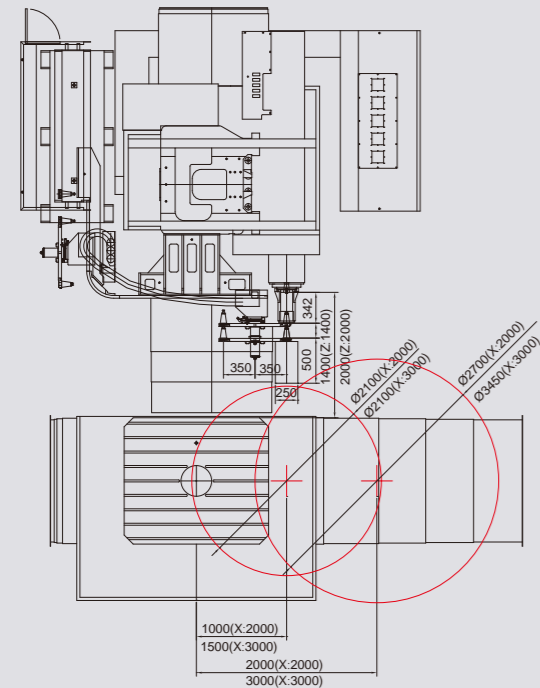

HBM-4T

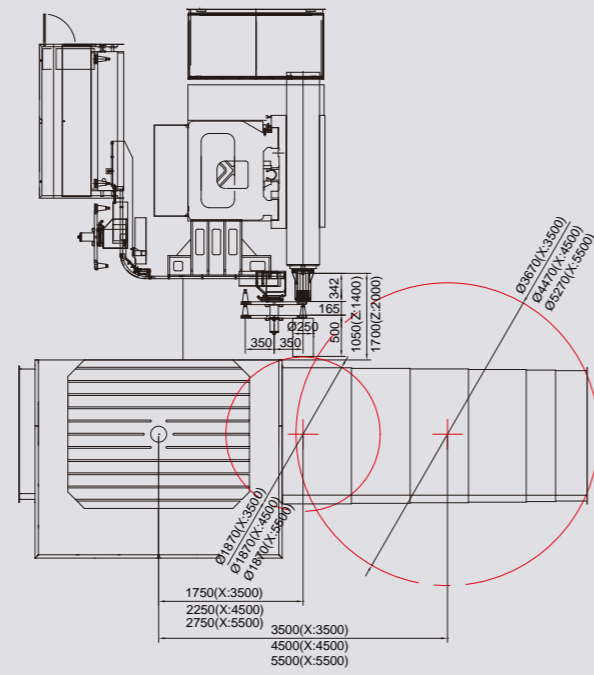

HBM-5T/5TL

Applied in various applications



Optical coating machine stainless steel vacuum chamber



Machine column



High speed screw production machine



Construction equipment



Housing of deep boring machine



A press brake machine frame (by angle head, opt.)



Deep boring of inner pipe hub



Turning big diameter hole by NC facing head(opt.)



Milling rope drums for Mining industry



Elbows for steel industry



Boring and drilling truck wheel axle



Milling and boring a fire-fight equipment